



# A new method to measure pulsed RF time domain waveforms with a sub-sampling system

T. Reveyrand<sup>1</sup> and Z. Popović<sup>2</sup>

<sup>1</sup> XLIM - CNRS, UMR 6172, 123 Av. A. Thomas, 87060 Limoges Cedex, France  
tibo@xlim.fr

<sup>2</sup> ECEE, University of Colorado at Boulder, 425 UCB, CO 80309, USA  
zoya@colorado.edu

# Table of contents

---

## 1 Bench

Setup

Calibration

## 2 Receivers

Mixer based (NVNA)

Sampler based (LSNA)

## 3 Algorithm

Frequency Analysis

Time-Frequency Analysis

## 4 Results

# Introduction

Designing very high efficiency Power Amplifiers requires transistors level characterizations such as :

- Large-signal measurements ;
- RF time-domain measurements ;
- Pulsed mode for radar applications ;

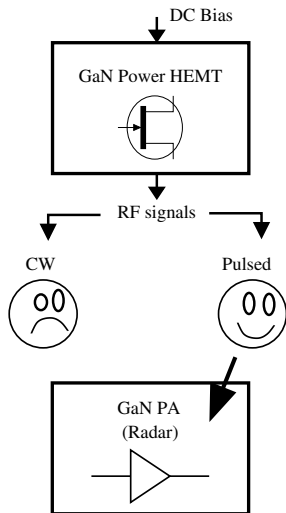

# Large-Signal Measurement Setup

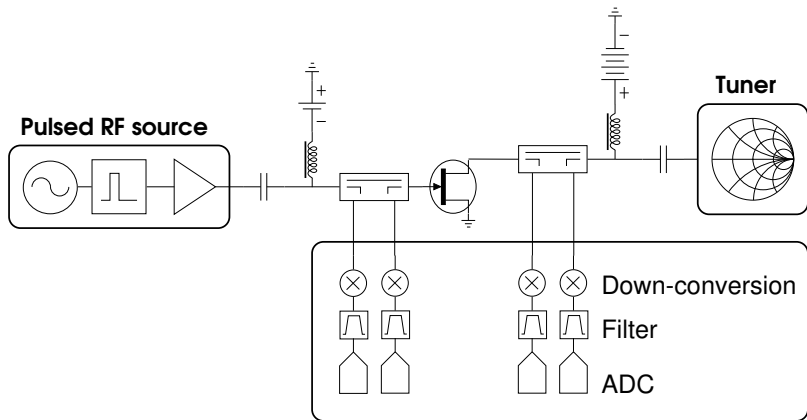

# Calibration Procedure (CW)

- SOLT
- Absolute Power
- Absolute Phase

$$\begin{pmatrix} a1 \\ b1 \\ a2 \\ b2 \end{pmatrix} = \|K\| \cdot e^{j \cdot \phi} \cdot \begin{bmatrix} 1 & \beta_1 & 0 & 0 \\ \gamma_1 & \delta_1 & 0 & 0 \\ 0 & 0 & \alpha_2 & \beta_2 \\ 0 & 0 & \gamma_2 & \delta_2 \end{bmatrix} \cdot \begin{pmatrix} R1 \\ R2 \\ R3 \\ R4 \end{pmatrix}$$

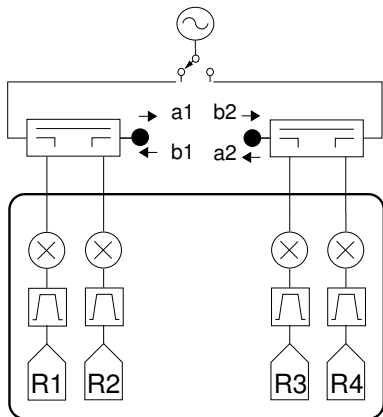

## Receivers for CW measurements

- NVNA approach : frequency domain

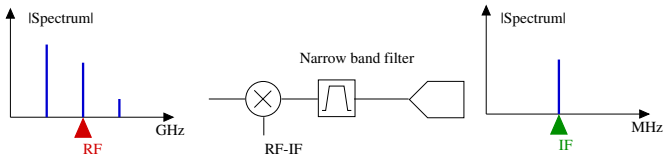

- LSNA approach : subsampling

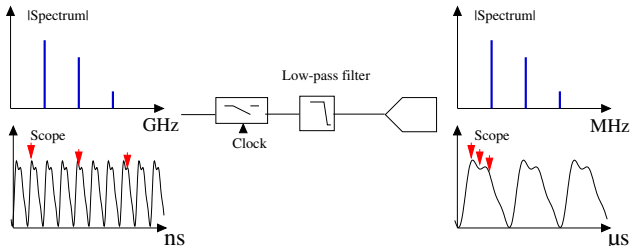

## Mixer based pulsed measurements (NVNA)

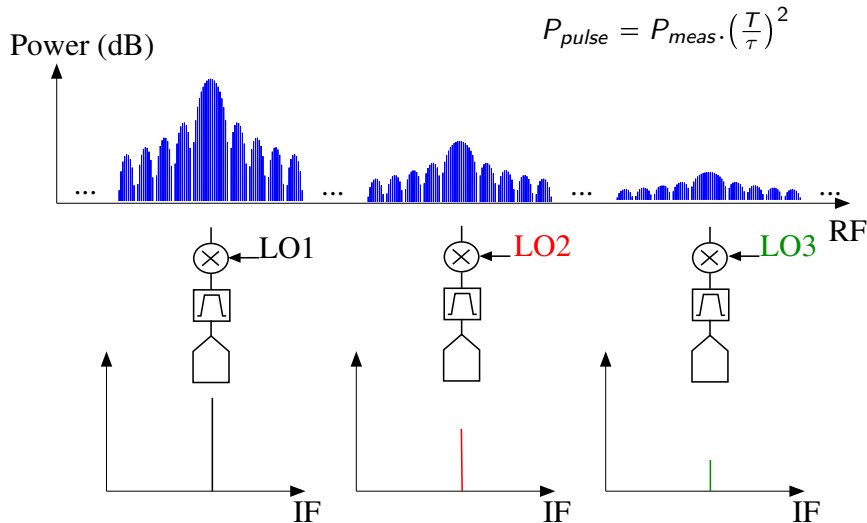

## Sampler based pulsed measurements (LSNA)

$$f_{RF} = 1.5\text{GHz}$$

$$\tau_{pulse} = 10\mu\text{s}$$

$$T_{IF} = 8\mu\text{s}$$

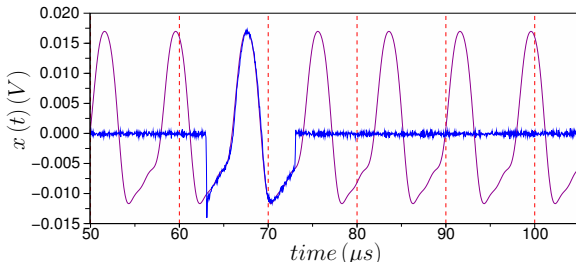
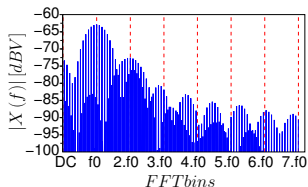
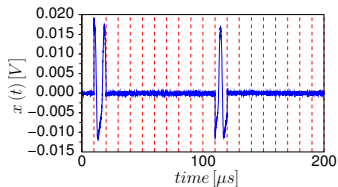



## About inner-products

---

According to a dictionary

$$\mathcal{D} = \{\psi_k\}_{k \in \Gamma}$$

$x(t)$  can be represented by its inner-products coefficients

$$\langle x, \psi_k \rangle = \int_{-\infty}^{+\infty} x(t) \cdot \bar{\psi}_k(t) \cdot dt$$

If  $x(t)$  is sparse in  $\mathcal{D}$  then

$$x(t) \approx \sum_{k \in \Lambda \subset \Gamma} \langle x, \psi_k \rangle \cdot \psi_k$$

# What is a Fourier Transform ?

- $\mathcal{D} = \{\psi_f(t) = e^{j \cdot 2 \cdot \pi \cdot f \cdot t}\}$
- $X(f) = \langle x, \psi_f \rangle$
- $x(t) = \int_{-\infty}^{+\infty} X(f) e^{j \cdot 2 \cdot \pi \cdot f \cdot t} df$
- $X(f) = \int_{-\infty}^{+\infty} x(t) e^{-j \cdot 2 \cdot \pi \cdot f \cdot t} dt$
- $x(t) \approx \sum_k X(k \cdot f_0) e^{j \cdot 2 \cdot \pi \cdot k \cdot f_0 \cdot t}$

Standard LSNA uses boxcar window

Projection basis :

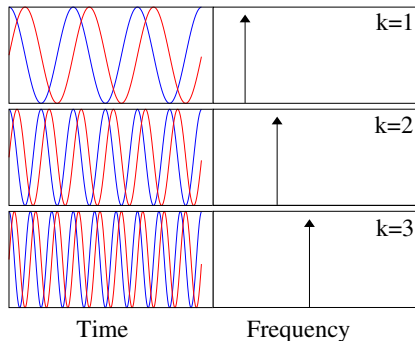

# The Short Time Fourier Transform

Rectangular STFT is well suited for harmonic analysis

Projection basis :

- $\mathcal{D} = \{\psi_{k,\tau}(t)\}$
- $\psi_{k,\tau}(t) = P_k \cdot \psi_k(t - \tau)$
- $\psi_k(t) = \Pi(f_0 \cdot t) e^{j \cdot 2 \cdot \pi \cdot k \cdot f_0 \cdot t}$
- $P_k = f_0 \cdot e^{j \cdot 2 \cdot \pi \cdot k \cdot f_0 \cdot \tau}$
- $X(k \cdot f_0, \tau) = \bar{P}_k \cdot X(t) * \bar{\psi}_k(t)$

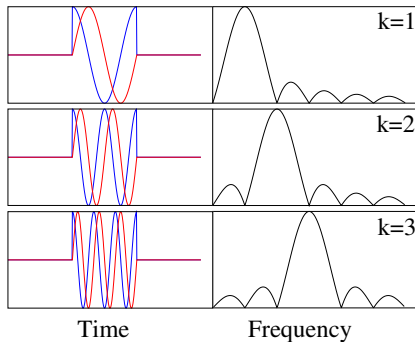

$$X(k \cdot f_0, \tau) = \bar{P}_k \cdot \mathcal{F}^{-1} \{ X(f) \cdot \bar{\Psi}_k(f) \}$$

# LSNA software modifications

Standard procedure

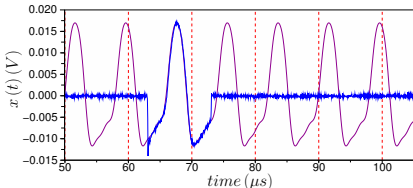
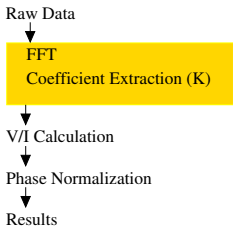

New procedure

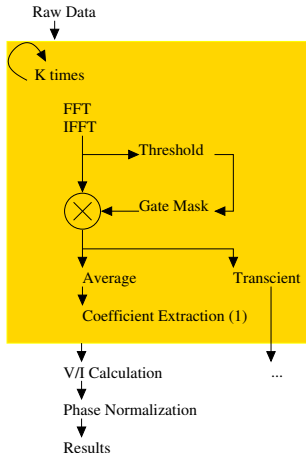

## Experimental view of the algorithm

$$f_{RF} = 1.5\text{GHz}$$

$$\tau_{pulse} = 10\mu\text{s}$$

$$T_{\psi} = 8\mu\text{s}$$

$$k \in \{1, 2, 3, 4\}$$

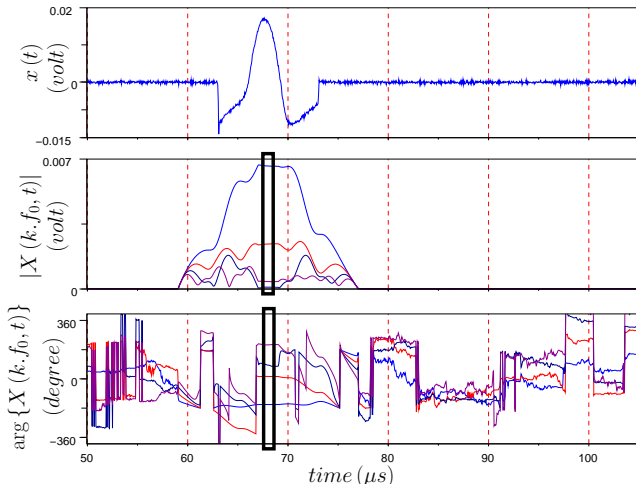

LSNA pulsed measurements on a PA ( $T = 100\mu s$ )

$$f_{RF} = 1.5GHz$$

$$T_{\psi} = 8\mu s$$

$$k \in \{1, 2, 3, 4\}$$

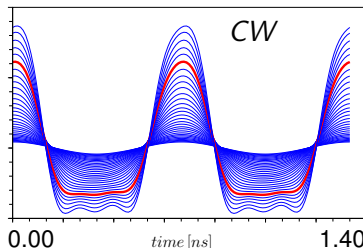
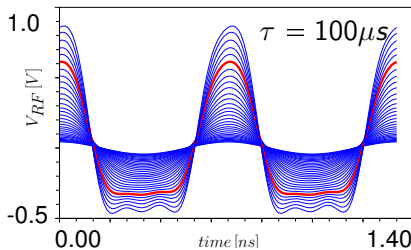
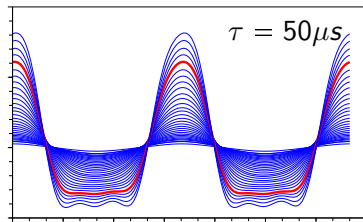
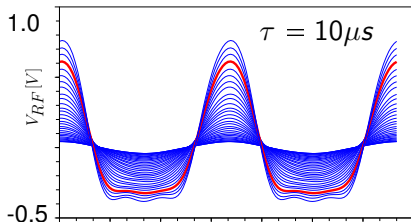

## Conclusion

---

- Standard LSNA hardware can measure pulsed RF
- Minimal software modification (FFT procedure)
- Compatible with CW and pulsed signals
- Adaptive method
  - No trigger
  - Pulse's width and period ( $\tau$ ,  $T$ ) not required
- Both 'Average' and 'Envelope Transcient' modes available

Future work :

- Narrow pulses (double aliasing)
- Other types of modulation